

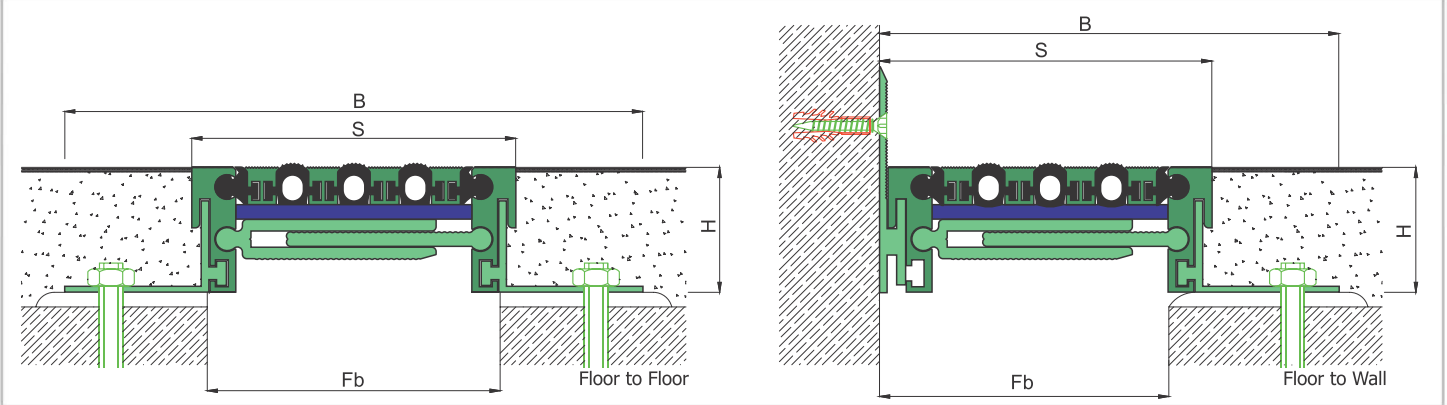

AS A226 flush mounted profiles can easily be applied to all types of floors and load bearing capacities are designed for heavy vehicles, cars or pedestrians depending on the gap inquired. Adjustable interlocking profile and gasket configuration makes it available for very large openings and enables to meet displacements in 3 directions. If inquired, AS A226 can be applied with wall type AS A126 and this dual application brings in a decorative aspect. Profiles are delivered factory-assembled.

- Application Areas** : Indoor & Outdoor / Floor
- Ideal for** : Factories, Warehouses, Car Parks, Shopping Malls, Airports, Residences, Hospitals, Hotels, Public & Commercial Buildings etc.
- Material** : Mill Finish Aluminum (Anodizing optional), TPE Gasket
- Aluminum Alloy** : 6063 AA-USA / EN AW 6063
- Optional Supplies** : Fire Barrier, Waterproof EPDM membrane

FLOOR

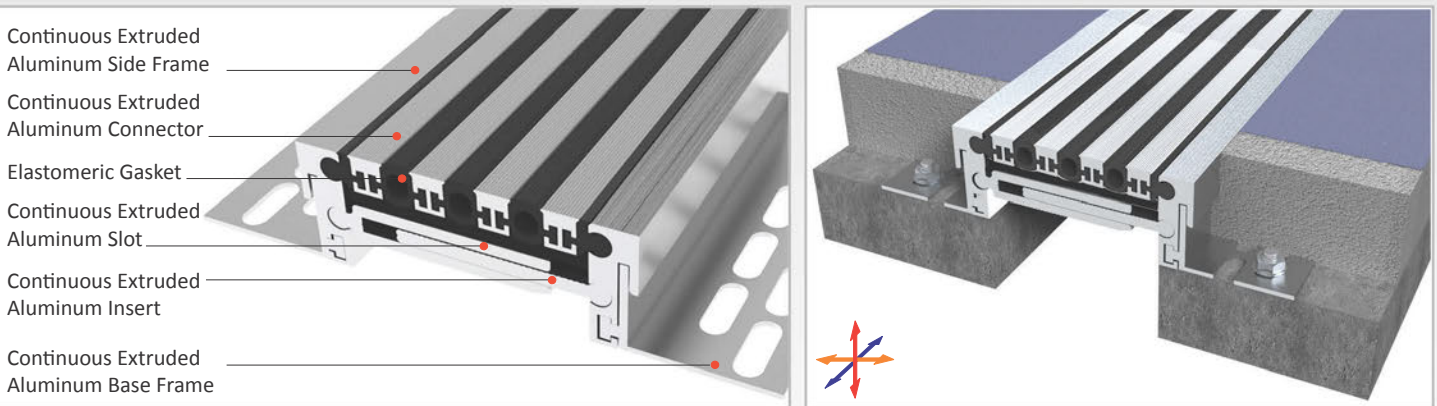

* Visuals are representative and the profile configuration may differ depending on the characteristics requested.

GASKET COLORS: **BLACK** GREY BEIGE Custom Colors available.

LOCATION	MODEL	GAP (Fb) mm	HEIGHT (H) MM	OVERALL WIDTH (B) mm	VISIBLE WIDTH (S) mm	MOVEMENT (W) mm	LOAD CAPACITY	STANDARD LENGTH (mt)
Floor to Floor	AS A226-035	35	43 / 58 / 68 / 88	135	48	± 2	70 kN 300 kN	3
	AS A226-050	50	43 / 58 / 68 / 88	158	70	± 4	35 kN 120 kN	3
	AS A226-080	80	43 / 58 / 68 / 88	180	92	± 6	25 kN 60 kN	3
	AS A226-100	100	43 / 58 / 68 / 88	200	112	± 8		3
	AS A226-120	120	43 / 58 / 68 / 88	220	133	± 10		3
	AS A226-140	140	43 / 58 / 68 / 88	240	153	± 12		3
	AS A226-160	160	43 / 58 / 68 / 88	268	180	± 14		3
	AS A226-180	180	43 / 58 / 68 / 88	280	193	± 16		3
	AS A226-200	200	43 / 58 / 68 / 88	305	218	± 18		3

Note: Please ask for different sizes



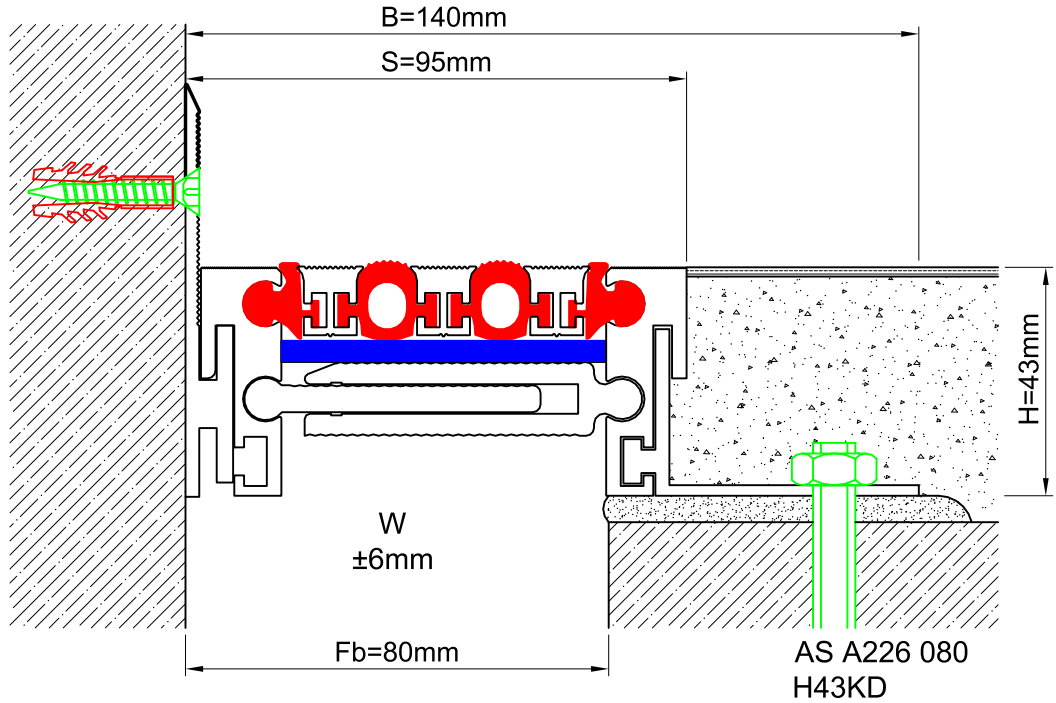
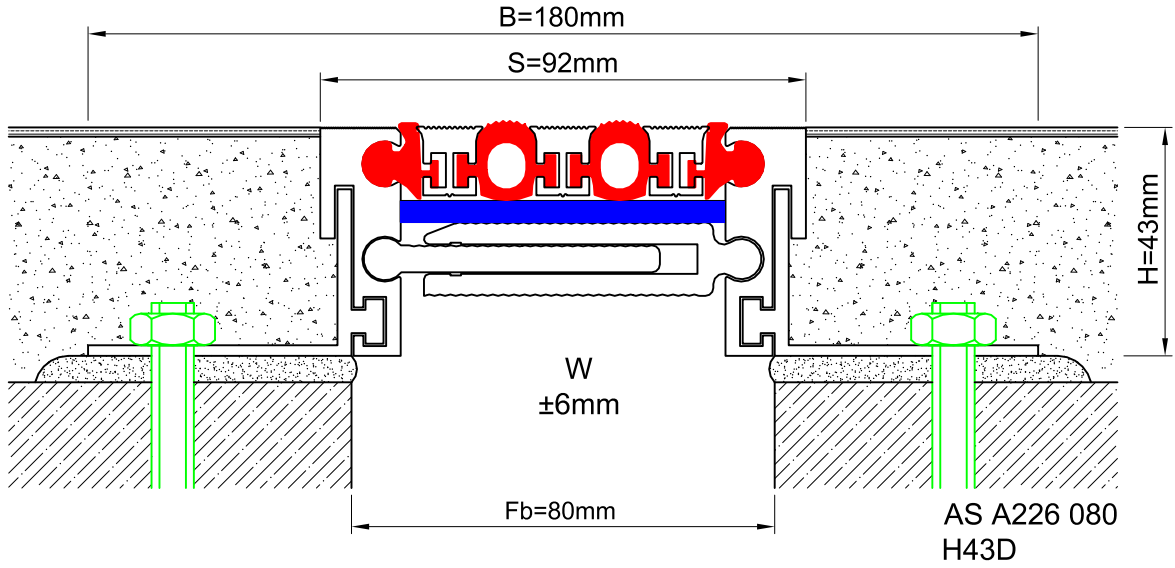

Profil No Profile Number	AS A226 080	AS A226 080K
Fb (mm)	80	80
H (mm) yaklaşık approx.	43	43
W± (mm) yaklaşık approx.	±6	±6
Renk Color	Alüminyum: Natürel, Fitiller: Siyah, gri, diğer Aluminum: Natural, Inserts: Black, grey, others	
Malzeme Material	Alüminyum, TPE Termoplastik Elastomer Aluminum, TPE Thermoplastic Elastomer	
Standart Uzunluk Standard Length	3	
Yükleme Kapasitesi Load-Bearing Capacity	25kN 	60kN 